

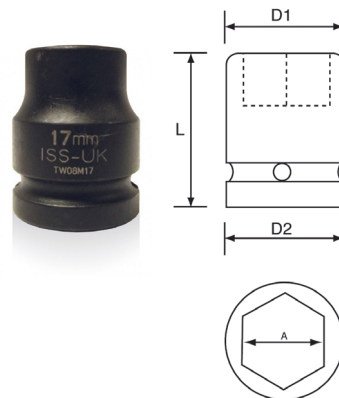

ERIKOISHYLSYT OHUTSEINÄHYLSYT, 1/2" VÄÄNTIÖ

A	Nimike		D2 mm	D1 mm	L mm	
	Vakio	Pitkä			Vakio	Pitkä
mm						
10	W08M10	W08M10L	25	15,5	38	78
13	W08M13	W08M13L	25	19,2	38	78
15	W08M15	W08M15L	30	21,7	38	78
16	W08M16	W08M16L	30	23	38	78
17	W08M17	W08M17L	30	24	38	78
18	W08M18	W08M18L	30	25	38	78
19	W08M19	W08M19L	30	26	38	78
21	W08M21	W08M21L	30	28	38	78
22	W08M22	W08M22L	30	29,5	38	78
23	W08M23	W08M23L	30	30,5	38	78
24	W08M24	W08M24L	30	32	50	78
27	W08M27	W08M27L	30	36	50	78
30	W08M30	W08M30L	30	40	50	78



OHUTSEINÄHYLSYT, 1" VÄÄNTIÖ

A	Nimike	D2 mm	D1 mm	L mm
mm				
19	W16M19L	54	33	100
24	W16M24L	54	38	100
27	W16M27L	54	42	100
28	W16M28L	54	43	100
30	W16M30L	54	45	100
32	W16M32L	54	47	100
33	W16M33L	54	49	100
34	W16M34L	54	49	100
36	W16M36L	54	52	100
38	W16M38L	54	54	100
41	W16M41L	54	57	100



OHUTSEINÄHYLSYT, TUULIVOIMALAKOOT

A	Nimike	Vääntiö	D1 mm	L mm
mm				
36	F12M36	3/4	50	65
36	F16M36	1	50	65
50	F16M50	1	68	80
60	F16M60	1	80	87
70	F16M70	1	92	96
60	F24M60	1 1/2	80	95
70	F24M70	1 1/2	92	116
80	F24M80	1 1/2	105	110
90	F24M90	1 1/2	120	115
80	F40M80	2 1/2	-	-
90	F40M90	2 1/2	-	-
100	F40M100	2 1/2	-	-





SURFACE DRIVE

A	Nimike	D2 mm	D1 mm	L mm
3/8" Vääntiö				
8	S06M08	19	13,8	32
9	S06M09	19	15	32
10	S06M10	19	16	32
11	S06M11	19	17,5	32
12	S06M12	19	19	32
13	S06M13	22	20	32
14	S06M14	22	22	32
15	S06M15	22	22	32
16	S06M16	22	24	32
17	S06M17	22	25	32
18	S06M18	22	26	32
19	S06M19	22	28	32
1/2" Vääntiö				
10	S08M10	25	17,5	38
11	S08M11	25	18,7	38
12	S08M12	25	20	38
13	S08M13	25	21	38
14	S08M14	25	22,5	38
15	S08M15	30	23,7	38
16	S08M16	30	25	38
17	S08M17	30	26	38
18	S08M18	30	27,5	38
19	S08M19	30	28,7	38
20	S08M20	30	30	38
21	S08M21	30	30	38
22	S08M22	30	32	38
23	S08M23	30	32	38
24	S08M24	30	35	45
26	S08M26	30	38	50
27	S08M27	30	38,7	50
29	S08M29	30	40	50
30	S08M30	30	42	50
32	S08M32	30	44	50

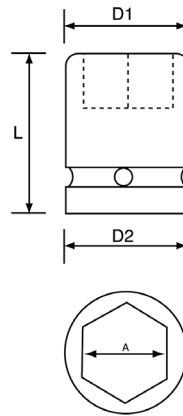



MAGNEETTISET KUUSIOHYLSYT

Vakiomalleissa kiinteä magneetti, pitkissä malleissa liukuva magneetti.

A	Nimike		D2 mm	D1 mm	L mm	
	Vakio	Pitkä			Vakio	Pitkä
1/4" Vääntiö						
5	M04M05	M04M05L	13	8,8	23	50
5,5	M04M05.5	M04M05.5L	13	9,5	23	50
6	M04M06	M04M06L	13	10	23	50
7	M04M07	M04M07L	13	11,3	23	50
8	M04M08	M04M08L	13	12,5	23	50
9	M04M09	M04M09L	13	13,8	23	50
10	M04M10	M04M10L	13	15	23	50
11	M04M11	M04M11L	13	16,3	23	50
12	M04M12	M04M12L	13	17	23	50
13	M04M13	M04M13L	13	18,8	23	50
14	M04M14	M04M14L	13	20	23	50
15	M04M15	M04M15L	13	21	23	50
3/8" Vääntiö						
6	M06M06	M06M06L	19	11,5	30	55
7	M06M07	M06M07L	19	12,5	30	55
8	M06M08	M06M08L	19	14	30	55
9	M06M09	M06M09L	19	15	30	55
10	M06M10	M06M10L	19	16,5	30	55
11	M06M11	M06M11L	19	17,5	30	55
12	M06M12	M06M12L	19	19	30	55
13	M06M13	M06M13L	22	20	30	55
14	M06M14	M06M14L	22	21,5	30	55
15	M06M15	M06M15L	22	22	30	55
16	M06M16	M06M16L	22	24	30	55
17	M06M17	M06M17L	22	25	30	55
18	M06M18	M06M18L	22	26	30	55
19	M06M19	M06M19L	22	27,5	30	55
1/2" Vääntiö						
8	M08M08	M08M08L	25	15	38	78
9	M08M09	M08M09L	25	16	38	78
10	M08M10	M08M10L	25	17,5	38	78
11	M08M11	M08M11L	25	18,7	38	78
12	M08M12	M08M12L	25	20	38	78
13	M08M13	M08M13L	25	21	38	78
14	M08M14	M08M14L	25	22,5	38	78
15	M08M15	M08M15L	30	23,7	38	78
16	M08M16	M08M16L	30	25	38	78
17	M08M17	M08M17L	30	26,5	38	78
18	M08M18	M08M18L	30	27,5	38	78
19	M08M19	M08M19L	30	29	38	78
20	M08M20	M08M20L	30	30	38	78
21	M08M21	M08M21L	30	31	38	78
22	M08M22	M08M22L	30	32,5	38	78
24	M08M24	M08M24L	30	35	38	78

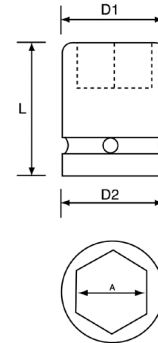



TORX-HYLSYT, 1/4" VÄÄNTIÖ

Koko	Nimike	D2 mm	D1 mm	L mm
E4	T04E04	13	7,2	25
E5	T04E05	13	8	25
E6	T04E06	13	9	25
E7	T04E07	13	9,5	25
E8	T04E08	13	10	25
E10	T04E10	13	12,5	25
E11	T04E11	13	13	25
E12	T04E12	14,5	14,5	25

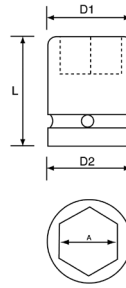

TORX-HYLSYT, 3/8" VÄÄNTIÖ

Koko	Nimike	D2 mm	D1 mm	L mm
E5	T06E05	19	9	32
E6	T06E06	19	10	32
E7	T06E07	19	10	32
E8	T06E08	19	10,5	32
E10	T06E10	19	12,5	32
E11	T06E11	19	14,5	32
E12	T06E12	19	15	32
E14	T06E14	19	17,5	32
E16	T06E16	19	19	32

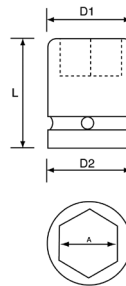

TORX-HYLSYT, 1/2" VÄÄNTIÖ

Koko	Nimike		D2 mm	D1 mm	L mm	
	Vakio	Pitkä			Vakio	Pitkä
E10	T08E10	T08E10L	25	15	38	78
E11	T08E11	T08E11L	25	15,5	38	78
E12	T08E12	T08E12L	25	16	38	78
E14	T08E14	T08E14L	25	18,5	38	78
E16	T08E16	T08E16L	25	20	38	78
E18	T08E18	T08E18L	25	22	38	78
E20	T08E20	T08E20L	30	25	38	78
E22	T08E22	T08E22L	30	26,5	45	78
E24	T08E24	T08E24L	30	28,5	45	78

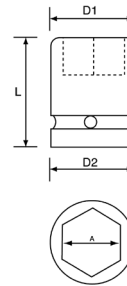

TORX-HYLSYT, 3/4" VÄÄNTIÖ

Koko	Nimike	D2 mm	D1 mm	L mm
E18	T12E18	44	25	56
E20	T12E20	44	27	56
E22	T12E22	44	30	56
E24	T12E24	44	33	56
E26	T12E26	44	36	56
E28	T12E28	44	39	56
E30	T12E30	44	42	56
E32	T12E32	44	44	56

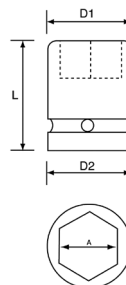



TORX-HYLSYT, 1" VÄÄNTIÖ

Koko	Nimike	D2 mm	D1 mm	L mm
E24	T16E24	54	36	65
E26	T16E26	54	39	65
E28	T16E28	54	42	65
E30	T16E30	54	45	65
E32	T16E32	54	48	65

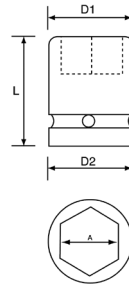

MUTTERIHYLSYT

Nimike		Vääntiö	Koko (GU/KM)
GU	KM		
GU0610	KM0610	3/8"	10
GU0612	KM0612	3/8"	12
GU0815	KM0815	1/2"	15
GU0817	KM0817	1/2"	17
GU0820	KM0820	1/2"	20
GU0825	KM0825	1/2"	25
GU0830	KM0830	1/2"	30
GU1235	KM1235	3/4"	35
GU1240	KM1240	3/4"	40
GU1245	KM1245	3/4"	45
GU1250	KM1250	3/4"	50



VAARNAHYLSYT

Nimike		Koko (vakiokierre)	Kanta mm	Pituus mm
Vakiokierre	Hienokierre			
3/8" Vääntiö				
VH06M05	-	M5 x 0.8	22	50
VH06M06	-	M6 x 1.0	22	50
VH06M07	-	M7 x 1.0	22	50
VH06M08	-	M8 x 1.25	22	50
VH06M10	VH06M10HK	M10 x 1.5	22	50
1/2" Vääntiö				
VH08M06	-	M6 x 1.0	25	55
VH08M07	-	M7 x 1.0	25	55
VH08M08	-	M8 x 1.25	25	55
VH08M10	VH08M10HK	M10 x 1.5	25	55
VH08M12	VH08M12HK	M12 x 1.75	25	55
VH08M14	VH08M14HK	M14 x 2.0	25	55
VH08M16	VH08M16HK	M16 x 2.0	30	75
VH08M18	-	M18 x 2.5	30	75
VH08M20	-	M20 x 2.5	30	75
1/2" Vääntiö UNC-kierre				
VH0808UNC	-	1/2 UNC	30	75
VH0810UNC	-	5/8 UNC	30	75
VH0812UNC	-	3/4 UNC	30	75
3/4" Vääntiö				
VH12M16	-	M16 x 2.0	44	100
VH12M18	-	M18 x 2.5	44	100
VH12M20	-	M20 x 2.5	44	100
VH12M22	-	M22 x 2.5	44	100
VH12M24	-	M24 x 3.0	44	100
VH12M27	-	M27 x 3.0	44	100
VH12M30	-	M30 x 3.5	44	100
VH12M33	-	M33 x 3.5	44	100
VH12M36	-	M36 x 4.0	44	100





NIVELHYLSYT

Nimike			Koko
1/4"	3/8"	1/2"	
mm			
NH04M05	-	-	5
NH04M05.5	-	-	5,5
NH04M06	-	-	6
NH04M07	-	-	7
NH04M08	-	-	8
NH04M09	NH06M09	-	9
NH04M10	NH06M10	NH08M10	10
NH04M11	NH06M11	NH08M11	11
NH04M12	NH06M12	NH08M12	12
NH04M13	NH06M13	NH08M13	13
NH04M14	NH06M14	NH08M14	14
NH04M15	NH06M15	NH08M15	15
-	NH06M16	NH08M16	16
-	NH06M17	NH08M17	17
-	NH06M18	NH08M18	18
-	NH06M19	NH08M19	19
-	NH06M20	NH08M20	20
-	NH06M21	NH08M21	21
-	NH06M22	NH08M22	22
-	-	NH08M23	23
-	-	NH08M24	24
tuuma			
NH0404	-	-	1/4"
NH0405	NH0605	-	5/16"
NH0406	NH0606	NH0806	3/8"
NH0407	NH0607	NH0807	7/16"
NH0408	NH0608	NH0808	1/2"
NH0409	NH0609	NH0809	9/16"
-	NH0610	NH0810	5/8"
-	NH0611	NH0811	11/16"
-	NH0612	NH0812	3/4"
-	NH0613	NH0813	13/16"
-	NH0614	NH0814	7/8"
-	-	NH0815	15/16"



JATKOVARRET

Nimike	Vääntiö	Kiinnitys	D2 mm	L mm
E04L50	1/4"	pallo	13	50
E04L100	1/4"	pallo	13	100
E04L150	1/4"	pallo	13	150
E04L250	1/4"	pallo	13	250
E04L300	1/4"	pallo	13	300
E04L350	1/4"	pallo	13	350
E04L450	1/4"	pallo	13	450
E06L44	3/8"	pallo	19	44
E06L75	3/8"	pallo	19	75
E06L125	3/8"	pallo	19	125
E06L150	3/8"	pallo	19	150
E06L200	3/8"	pallo	19	200
E06L250	3/8"	pallo	19	250
E06L300	3/8"	pallo	19	300
E08L50	1/2"	pallo	25	50
E08L75	1/2"	pallo	25	75
E08L100	1/2"	pallo	25	100
E08L125	1/2"	pallo	25	125
E08L150	1/2"	pallo	25	150
E08L200	1/2"	pallo	25	200
E08L250	1/2"	pallo	25	250
E08L300	1/2"	pallo	25	300
E08L375	1/2"	pallo	25	375
E08L450	1/2"	pallo	25	450
E08L600	1/2"	pallo	25	600
E08L900	1/2"	pallo	25	900
E12L75	3/4"	reikä	44	75
E12L100	3/4"	reikä	44	100
E12L125	3/4"	reikä	44	125
E12L150	3/4"	reikä	44	150
E12L200	3/4"	reikä	44	200
E12L250	3/4"	reikä	44	250
E12L300	3/4"	reikä	44	300
E12L400	3/4"	reikä	44	400
E16L100	1"	reikä	54	100
E16L150	1"	reikä	54	150
E16L200	1"	reikä	54	200
E16L250	1"	reikä	54	250
E16L300	1"	reikä	54	300
E16L400	1"	reikä	54	400
E24L150	1 1/2"	reikä	86	150
E24L250	1 1/2"	reikä	86	250
E24L500	1 1/2"	reikä	86	500



NIVELJATKOT

Nimike	Vääntiö	Tyyppi	D2 mm	L mm
NL04	1/4"	pallo	16	43
NL06	3/8"	pallo	24	50
NL08	1/2"	pallo	32	60
NL12	3/4"	reikä	44	90
NL16	1"	reikä	54	110
NL16HC	1"	reikä	58	118
NL24	1 1/2"	reikä	86	182
NL40	2 1/2"	reikä	152	248





NELIKULMAHYLSYT

Nimike	Koko	D2 mm	D1 mm	Pituus mm
3/8" Vääntiö				
N06M05	5 mm	19	12	25
N06M06	6 mm	19	14	25
N06M07	7 mm	19	15	25
N06M08	8 mm	19	16	25
N06M09	9 mm	19	17,5	25
N06M10	10 mm	19	19	25
1/2" Vääntiö				
N08M07	7 mm	25	17,5	40
N08M08	8 mm	25	19	40
N08M09	9 mm	25	20	40
N08M10	10 mm	25	21,5	40
N08M11	11 mm	25	23	40
N08M12	12 mm	25	24	40
N08M13	13 mm	30	26	40
N08M14	14 mm	30	27,5	40
N08M15	15 mm	30	28,5	40
N08M16	16 mm	30	30	40
N08M17	17 mm	30	32	40
N08M18	18 mm	30	34	45
N08M19	19 mm	30	26	45
N08M20	20 mm	30	38	45
N08M21	21 mm	30	40	45
N08M22	22 mm	30	42	45
N08M24	24 mm	30	44	50
N08M26	26 mm	30	48	50
N08M27	27 mm	30	49	50
N08M28	28 mm	30	50	50
N08M30	30 mm	30	53	50
N08M32	32 mm	30	56	50
N08M36	36 mm	38	62	55
N0806	3/8"	25	21	40
N0808	1/2"	30	26	40
N0810	5/8"	30	30	40
N0812	3/4"	30	36	45
N0814	7/8"	30	42	45
N0816	1"	30	46	50
N0820	1 1/4"	30	56	50

Nimike	Koko	D2 mm	D1 mm	Pituus mm
1" Vääntiö				
N16M17L	17 mm	52	40	100
N16M19L	19 mm	50	43	100
N16M20	20 mm	-	-	-
N16M21	21 mm	-	-	-
N16M21L	21 mm	52	44	100
N16M22	22 mm	-	-	-
N16M23	23 mm	-	-	-
N16M24	24 mm	-	-	-
N1613L	13/16"	54	46	95
N16M21M28	21 x 28 mm	62	62	70
N16M21M28L	21 x 28 mm	62	62	110



HEX-POWERDRIVE -HYLSYT, 1/4" VÄÄNTIÖ

Nimike		Koko mm	Pituus mm
Kiinteä magneetti	Liukuva magneetti		
HH04M05.5M	HH04M05.5LM	5,5	75
HH04M06M	HH04M06LM	6	75
HH04M07M	HH04M07LM	7	75
HH04M08M	HH04M08LM	8	75
HH04M10M	HH04M10LM	10	75
HH04M11M	HH04M11LM	11	75
HH04M12M	HH04M12LM	12	75
HH04M13M	HH04M13LM	13	75
HH04M14M	HH04M14LM	14	75

