

CE



# Torque Tool Tester (T T T)Series 3

**OPERATOR'S HANDBOOK (Part No. 34308) Issue 1**  
(ENGLISH)

FOR USE WITH TTT'S FITTED WITH VERSION 37712.301 SOFTWARE

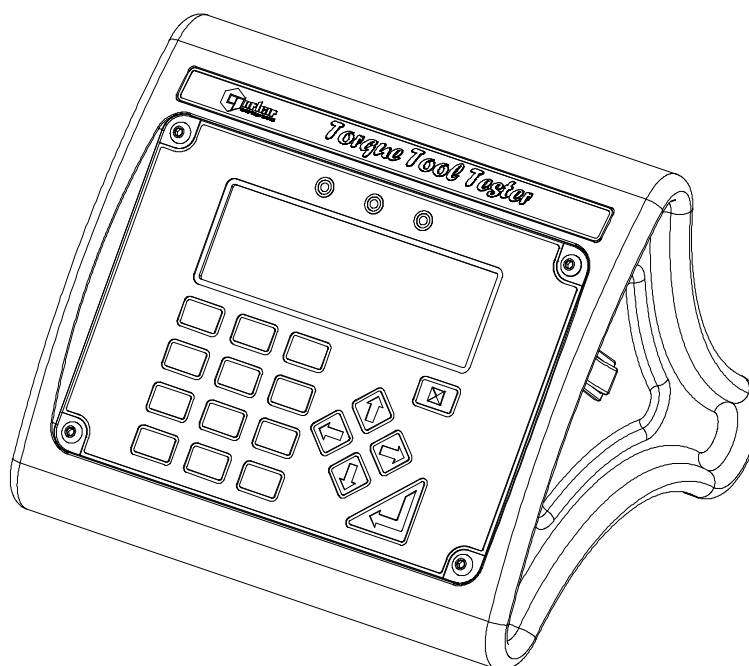

## **PART NUMBERS COVERED BY THIS MANUAL**

**43228 TTT**

NORBAR TORQUE TOOLS LTD, Beaumont Road, Banbury, Oxfordshire, OX16 1XJ, UNITED KINGDOM  
Tel: + 44 (0) 1295 270333, Fax: + 44 (0) 1295 753643

[www.norbar.com](http://www.norbar.com)

[enquiry@norbar.com](mailto:enquiry@norbar.com)



# CONTENTS

	<u>PAGE</u>
<b>Introduction</b>	<b>2</b>
Parts included	2
Accessories	2
<b>Features and Functions</b>	<b>3</b>
<b>Set Up</b>	<b>4</b>
Preparation	4
Set Up for use	5
1. Limits	5
2. Settings	6
3. Return to measure	6
Flow Diagrams	7
<b>Measure</b>	<b>10</b>
User units	11
Using the key pad	11
Screen Layout	12
Modes of measurement	14
Power saving & power down	15
Limits	16
<b>Transducer Interface</b>	<b>18</b>
<b>Ancillaries</b>	<b>20</b>
<b>Serial Port</b>	<b>22</b>
<b>Specifications</b>	<b>25</b>
<b>Maintenance</b>	<b>26</b>
<b>Trouble Shooting</b>	<b>27</b>
<b>Glossary of Terms</b>	<b>28</b>

## INTRODUCTION

Torque Tool Tester (TTT) is a bench top measuring instrument which has three transducer inputs. It has 10 measurement modes, 13 units of torque (with additional USER units feature), 12 pairs of limits and text displayed in 11 languages.

### PARTS INCLUDED:- \_\_\_\_\_

Description	Part Number	Quantity
Torque Tool Tester Instrument.	43228	1
a.c. power adapter.	38877	1
Power cord.	-	1
Operators Handbook.	34308	1
Calibration Certificate.	-	1
Quick reference card(s).	34315	-
Serial data lead.	39264	1
TTT carry case.	26716	1

### ACCESSORIES:- \_\_\_\_\_

Description	Part Number
TTT to 10 way lead, for Norbar Rotary Transducers.	60216.200
TTT to 6 way lead, for Norbar Static & Annular Transducers.	60217.200
TTT to no connector (for non-Norbar transducers).	60223.200
Serial Data Lead Kit.	60248
Extensive range of torque transducers.	Contact Norbar

## FEATURES AND FUNCTIONS

- The pictorial panel allows easy mode selection for the 6 modes of operation. Additionally the 4 Peak modes can be configured for automatic reset.
- 3 transducer connectors.
- Automatically recognises any 'SMART' Norbar transducer. Can also work with most mV/V transducers from Norbar or other manufacturers.
- 13 Torque units, plus the ability to specify USER measurement units up to a maximum of 6 characters.
- 5 digit resolution for all Norbar transducers.
- Operational from internal rechargeable battery or a.c. supply.
- Fast battery charge in 3 hours 20 minutes.
- There are 12 pairs of limits available. Each limit has a target value and upper and lower tolerances. The display shows LO / OK / HI with bright LED's to signal AMBER / GREEN / RED for easy confirmation. The limit status is also output on the ancillaries connector and serial port.
- Pulse count feature in 'Impulse Tool' mode & 'Clutch Tool' mode.
- User selectable frequency response for each mode of operation.
- Password protection of all selectable features. The instrument can be issued to an operator with only the required modes of operation and units of measurement enabled. This feature can virtually eliminate operator induced errors.
- Ancillaries connector with analogue output & GO/NO GO control for external equipment.
- Serial Port for data output to a PC or printer. Serial Port set up options include: sending time & date, limit status and continuous output.

## SET UP

### PREPARATION:-

*If the equipment is used in a manner not specified by the manufacturer, the protection provided by the equipment may be impaired.*

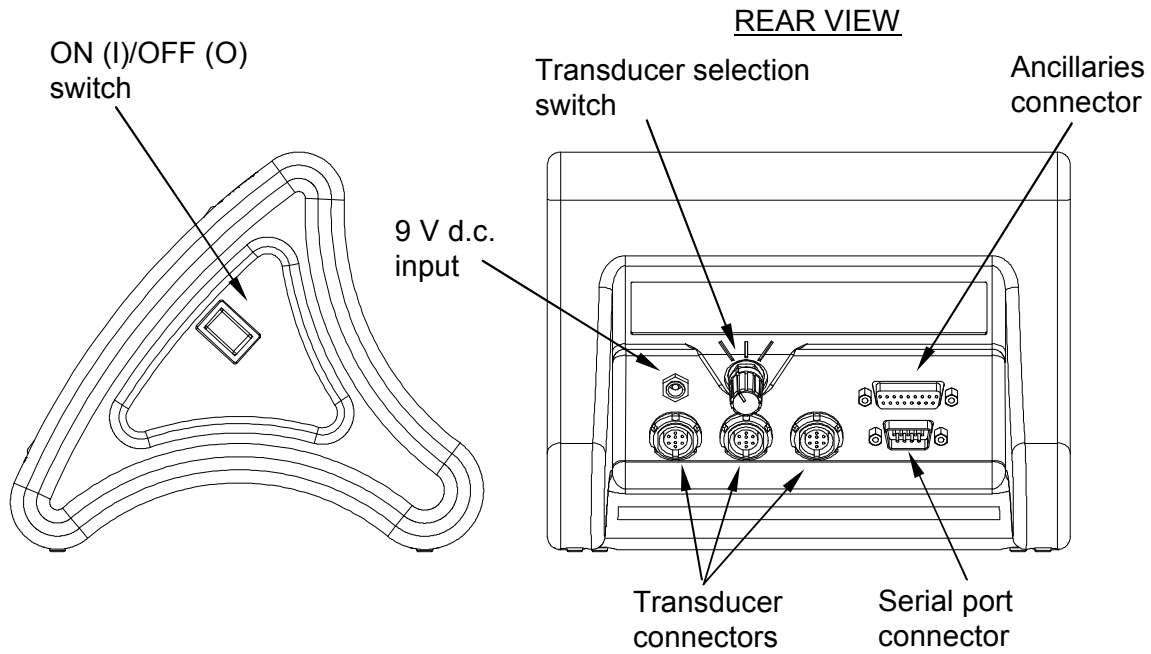

1. Connect transducer(s) to be used by inserting transducer cable(s) into the desired transducer connector(s).
2. Ensure transducer selection switch is in the correct position for the transducer in use (TD#1, TD#2 or TD#3). See the symbols above the transducer connectors or indication on the TTT display when power is ON.
3. To output data to an external device (PC or printer) connect to the SERIAL PORT.
4. If using with a control or shut-off system, connect to ANCILLARIES connector.

**WARNING! ALLOW THE TTT TO EQUALISE TO THE AMBIENT TEMPERATURE/HUMIDITY BEFORE SWITCHING ON. WIPE OFF ANY MOISTURE BEFORE USE.**

5. The TTT can be powered from mains or battery. It is essential to charge the internal battery for 200 minutes (3 hours & 20 minutes) for full charge. To charge the internal battery, connect the a.c. power adapter between the TTT (9 V d.c. input) and a live a.c. supply.

TIP: Insert 9 V d.c. connector into TST before applying a.c. mains to ensure correct charging.

TIP. If the power cord has no plug fitted, wire as follows:  
BROWN-LIVE                      BLUE-NEUTRAL                      GREEN / YELLOW-EARTH  
If in doubt consult a qualified electrician.

TIPS: The display backlight is ON when connected to a.c. power.  
The TTT can be used whilst the battery is charging.  
Recharging is independent of the on/off switch.  
The battery can be charged continuously.

**SET UP FOR USE:-** \_\_\_\_\_

Turn TTT on and wait for LOGO.

The TTT will either enter the measure screen or display 'CONNECT TRANSDUCER'.

Press  to obtain SET UP menu:

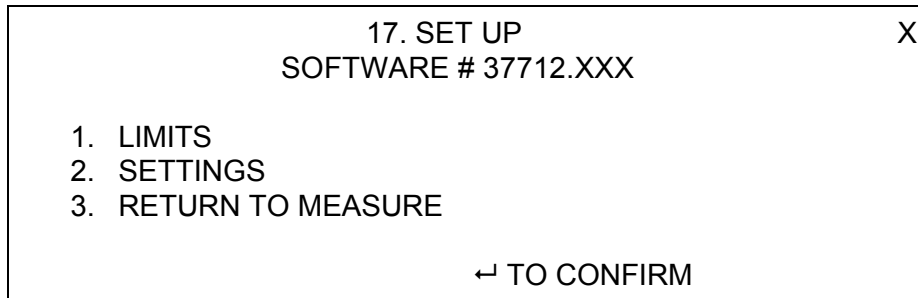

*NOTE: The set up is password protected, the default password is 000000.*

TIP: If password is lost, contact Norbar quoting the coded number in brackets on the password menu.

TIP: When in a set up screen, after entering one option press the down arrow to enter the next. When all entry's have been made, press '↵'.

**1. LIMITS**

The user can set up to 12 target values that each have two settable LIMITS.

To set the limits the following are needed:

Parameter	Comment
Target Number	Select 1 to 12.
Units for limits	Select torque units (or specify USER units).
Target value	Torque value required.
Upper limit	The % allowed above target.
Lower limit	The % allowed below target.
Operate	OFF or Clockwise or Anticlockwise or Both directions.
Confirm limits	Limit values shown in % of the target value.

Select next target to set up. Press  when finished.

For more information see flow diagram on page 7.

**2. SETTINGS**

Setting	Options (defaults)	Comment
LANGUAGE	ENGLISH (default), FRANCAIS, DEUTSCH, ITALIANO, ESPAÑOL, DANSK, NEDERLANDS, SUOMI, NORSK, SVENSKA, PORTUGUES.	Set language of operation.
PASSWORD	Any 6 numeric characters (default = '000000').	Set Password.
DATE & TIME	Set date DD/MM/YY or MM/DD/YY.	24 hour clock with date.
MODE FREQUENCY	100Hz to 2500Hz (defaults, see 'MODES OF MEASUREMENT' section).	Select mode then select frequency from list. OTHER FREQUENCY allows a custom value.
SERIAL PORT	See 'SERIAL PORT' section.	Select required options.
THRESHOLDS	FIRST PEAK SENSITIVITY = LOW / MEDIUM / HIGH (default = HIGH).	This is the amount by which the torque must drop to register a first peak. LOW must drop 10% of reading. MEDIUM must drop 5% of reading. HIGH must drop 2.5% of reading.
THRESHOLDS	AUTO RESET HOLD TIME = 1 (default) / 2 / 3 / 4 seconds.	The time allowed for automatic reset in 'Click & Cam' mode.
THRESHOLDS	TRIGGER FROM = 0.5% to 99% of transducer capacity (default = 1.8 %).	This is the point at which any memory mode starts to work, all memory modes will 'TRACK' below this setting. This can help overcome false results. Values entered below 0.5% will act as 0.5%.
THRESHOLDS	PEAK MEMORY RESET = AUTO / MANUAL (default).	All Peak modes will reset the highest reading automatically or manually.
UNITS	All units (default = all enabled).	Turn off unwanted torque units.
MODES	All modes (default = all enabled).	Turn off unwanted modes.
POWER DOWN TIME	0 to 99 minutes (default = 10).	The time before power down starts. Set to '0' to disable.
PRINT SETTINGS	None.	All settings and limit settings can be printed. No password is needed.

TIP: When ↑ or ↓ is shown on screen, this means more menu items are available.

For more information see flow diagram on page 9.

**3. RETURN TO MEASURE**

This option allows the user to view the measurement screen.

For 'SMART' transducers the measure screen is automatically entered.

For 'NON-SMART' transducers the option to store transducer details is available.

For more information see flow diagram on pages 7 & 8.



**FLOW DIAGRAMS:-**

All set up menus are numbered on the TTT for ease of identification.

**Menu structure + limits flow diagram**

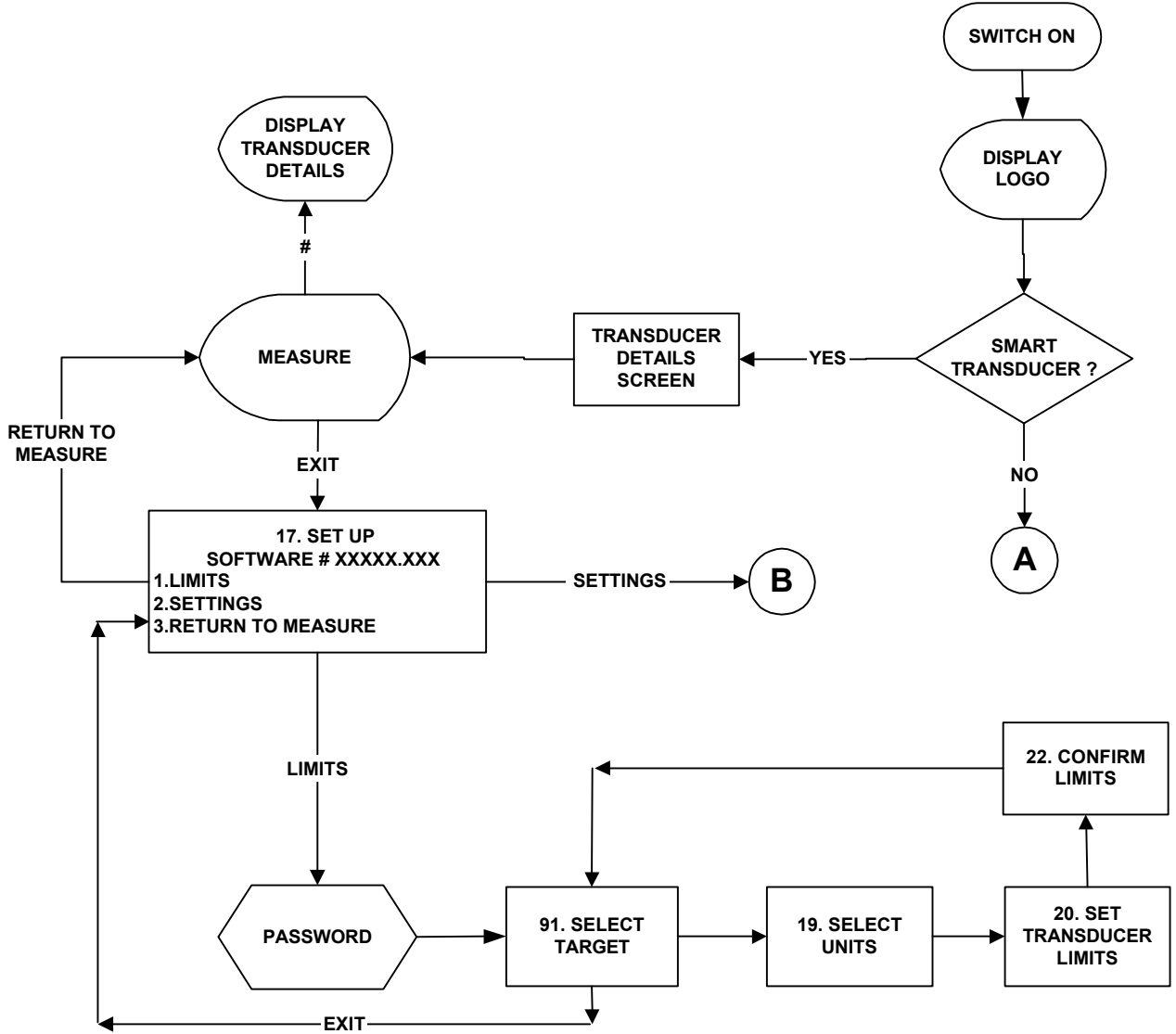

**Password flow diagram**

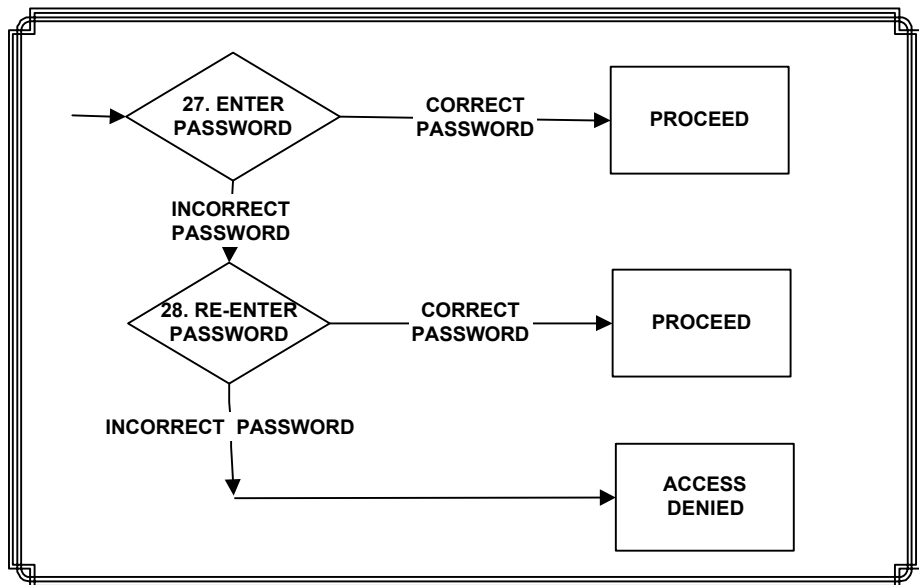

**Measure flow diagram**

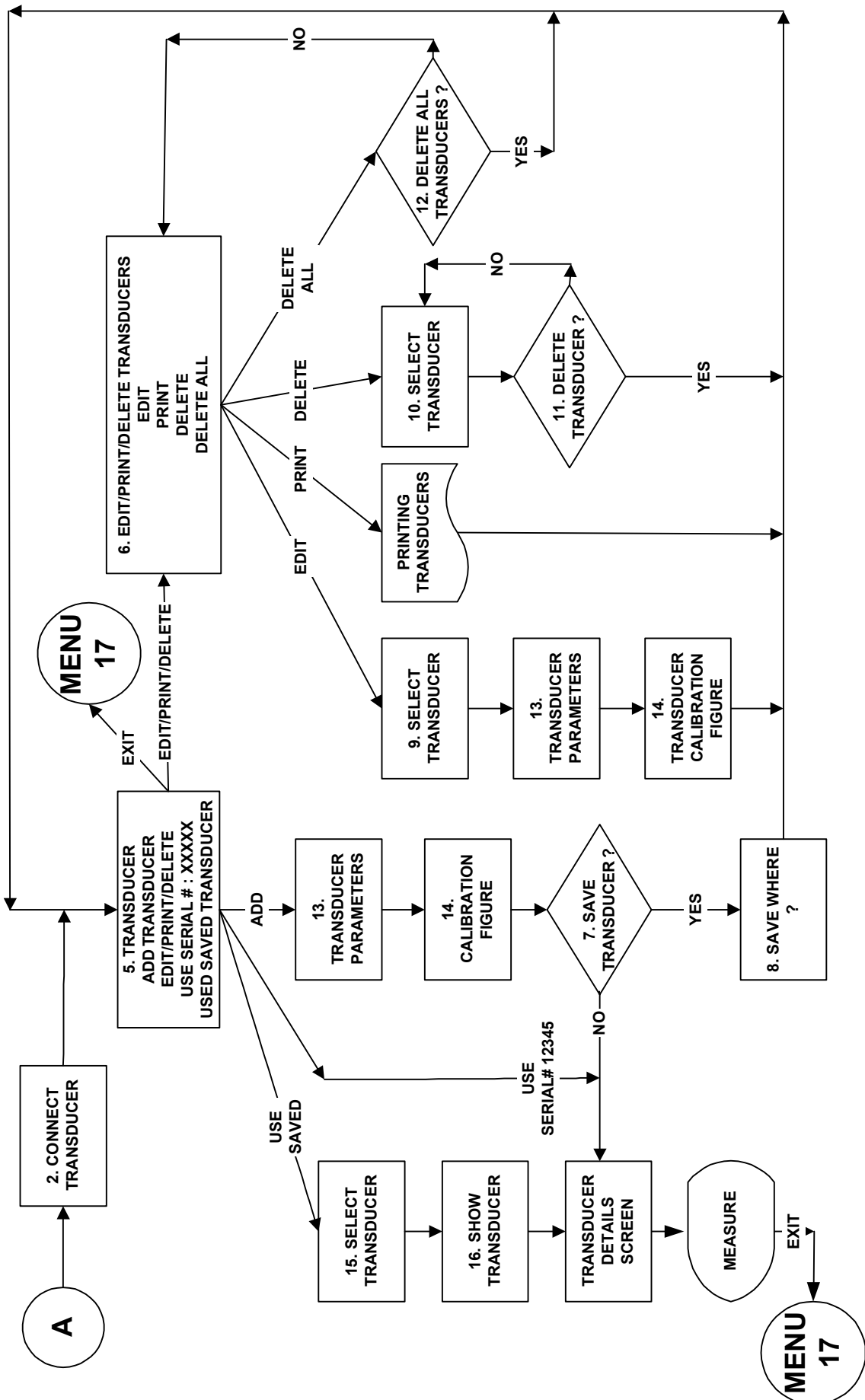

**Settings flow diagram**

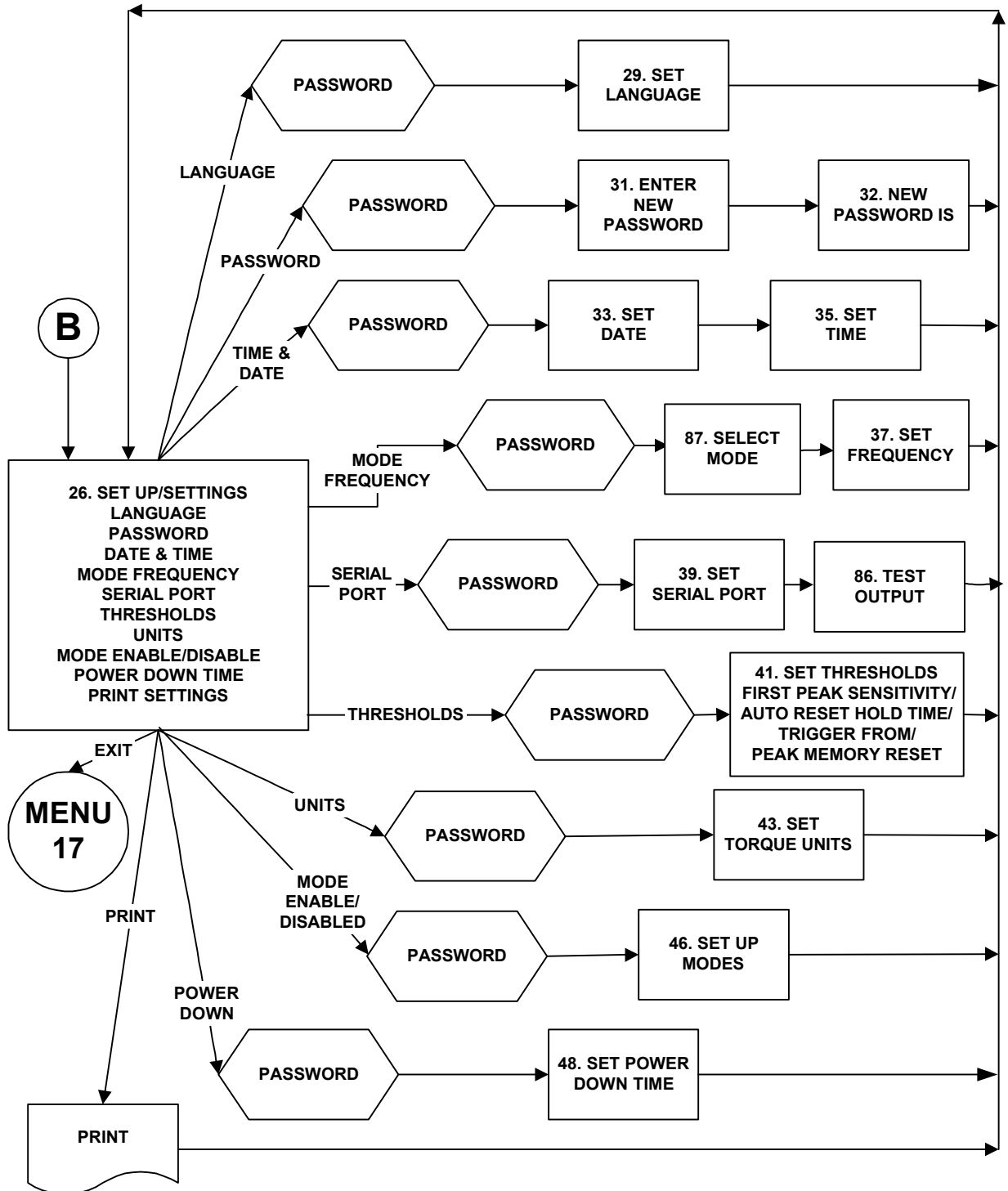

## MEASURE

1. Set up the TTT as described in the previous section.
2. Turn TTT on.
3. For 'SMART' transducers the TTT automatically shows the transducer input selected (TD#1, TD#2 or TD#3), the transducers capacity and units. The transducer's serial number and direction of linearization (if enabled) are also shown. The instrument then displays the measurement screen.

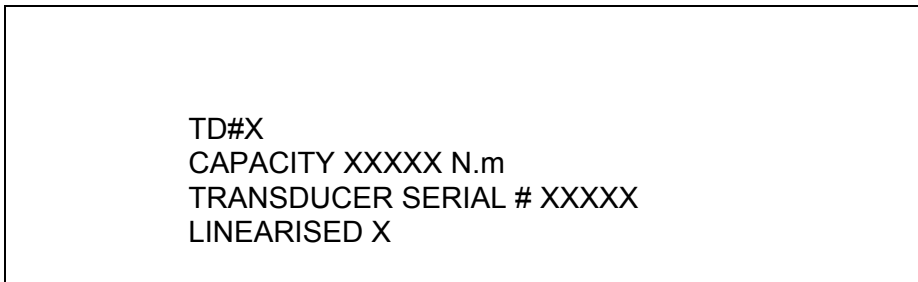

*Note: If the word 'LINEARISED' and direction arrows appear on this screen then the TTT is using a second order polynomial to linearise the transducer.*

4. If 'Menu 2' is shown, then either:
  - a). A 'SMART' transducer is not connected.
  - b). The transducer is 'NON-SMART'.  
 For 'NON-SMART' transducers the transducer details can be saved in the TTT for future use. Transducer details can be edited, deleted or printed. The last transducer used will always be retained for quick selection.  
 Follow 'measure flow diagram' in SET UP section & refer to TRANSDUCER INTERFACE section.

TIP. For entry of transducer data, see the 'USER UNITS' and 'USING THE KEY PAD' sections on page 11.

- c). The 'Transducer Selection switch' is in the wrong position.
5. The TRACK screen is now displayed. Exercise the transducer in required direction of use.
6. Press 'ZERO' to zero displayed reading.

TIP. The measurement display may not zero if outside +/-3% of transducer capacity. This may be due to transducer overstrain. Return defective transducer to Norbar.

7. Select measurement mode required.

TIP. If any measurement mode does not memorise the measurement value, ensure that the 'TRIGGER FROM' setting is correct. See SETTING, THRESHOLDS menu. TRIGGER FROM can be used to overcome erratic results being obtained.

8. Press  to exit any measurement screen and go to SET UP.

**USER UNITS:-** \_\_\_\_\_

This feature allows the USER to specify custom measurement units that are displayed after the measurement value and printed on the serial port. Any mV/V transducer conforming to the specifications in the TRANSDUCER INTERFACE section can be used. Typical examples could be load or pressure transducers.

- 1) When '2. MEASURE' is displayed, press '↵ TO CONFIRM'.
- 2) Select '13. ADD TRANSDUCER' and press '↵ TO CONFIRM'.
- 3) Enter 'SERIAL #:' and press '↓'. Enter 'PART NUMBER: (if required)' and press '↓'.
- 4) The user can choose the 'UNITS OF CALIBRATION:'. Press  whilst the display is showing 'N.m', 6 underscores will be displayed (\_\_\_\_\_). Now input the required 'UNITS OF CALIBRATION', for example 'kN'. Press '↓' when input has finished.
- 5) Enter 'RATED CAPACITY:', press '↵ TO CONFIRM'.

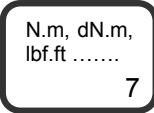
TIP. The  button will have no effect when in measure.





TIP. Only limits set up in the same USER units are available for selection when in measure.

**USING THE KEY PAD:-** \_\_\_\_\_

Press and hold the required key until the desired character is displayed, then release.

Key	1	2	3	4	5	6	7	8	9	0
Character	1, a, A, b, B, c, C	2, d, D, e, E, f, F	3, g, G, h, H, i, I	4, j, J, k, K, l, L	5, m, M, n, N, o, O	6, p, P, q, Q, r, R	7, s, S, t, T, u, U	8, v, V, w, W	9, x, X, y, Y, z, Z	0

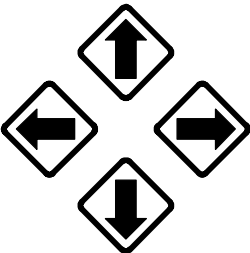

NOTE: -. The keys 0 – 9 are shortcuts for menu selection.

Key	Function
	Entry of: # % ( ) * , / : = \ _
	Entry of: . (full stop or decimal point) + -
	a) Navigate menu options and choices. b) Left arrow becomes delete when entering data. c) Right arrow becomes space when entering data. d) Down arrow moves on to next option in a set up menu. e) Use left and right arrows for quick selection of torque units in measurement screen.
	Confirm change.  NOTE: If the change is not confirmed, it will not be made.

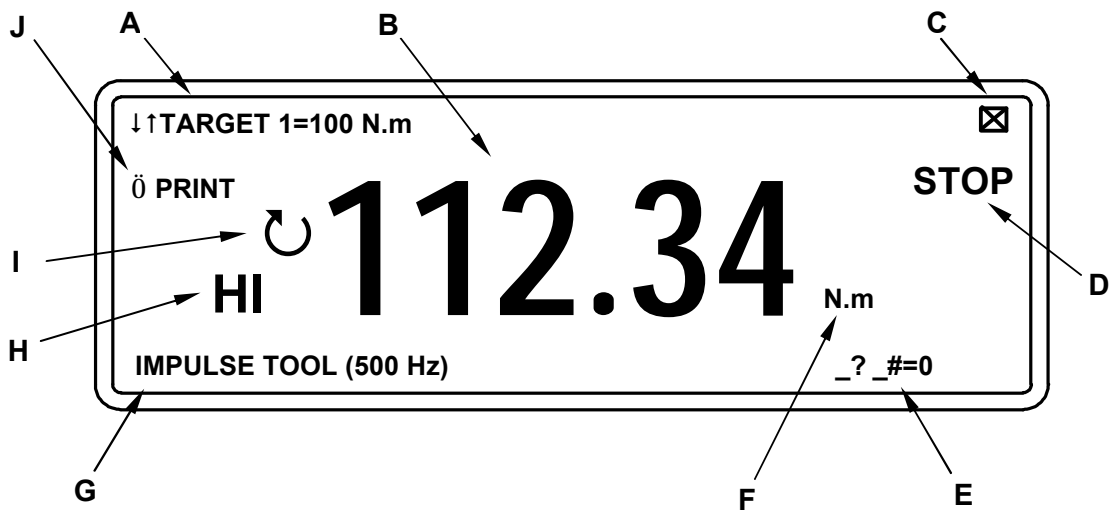
SCREEN LAYOUT:- \_\_\_\_\_



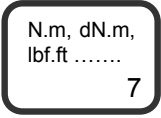
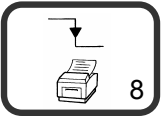

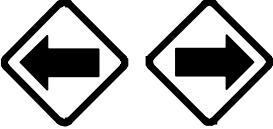
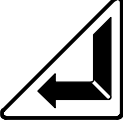

A. Press		to select target value and associated limits to be used.  Time/Date shown if no targets set.	
B. Measurement reading.			
C. Press		to exit.	
D. Indicates when to stop loading in		CLICK & CAM measurement mode.	
E. Pulse count when in		or	measurement modes.
In 'IMPULSE TOOL' & 'CLUTCH TOOL' modes, a count is added every time the torque passes above & below the 'trigger from' setting.			
F. Units of measurement			
G. Current 'mode of measurement' in use along with frequency response set for that mode.			
H. Limit indication (if enabled).			
I. Direction of measurement.			
J. Press		to toggle between '√ PRINT' and 'X PRINT' on the display. √ PRINT enables serial port, X PRINT disables serial port.	

Key	Function
	Selection of enabled torque units.
	PRINT reading and RESET.
	To view transducer details in track mode. Shows: Serial #, Part Number, Units & Rated Capacity. Clockwise & anticlockwise mV/V Calibration figures. Angle option programmed (for use with Pro-Log instrument) Clockwise & anticlockwise linearised values, where $T = a + bR + cR^2$ (T is torque & R is Ratio in mV/V).
	TRACK mode: - Zero transducer (It is recommended to check the zero when returning from power down). All other modes: - PRINT reading and RESET.
	For selection of torque units.
	PRINT reading and RESET.

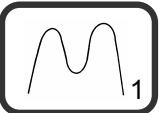
**TIP.** To simplify operation disable all units of measurement not required. See SETTINGS, UNITS ENABLE/DISABLE menu.

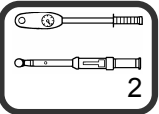
**MODES OF MEASUREMENT:-** \_\_\_\_\_

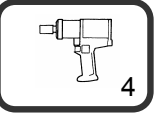
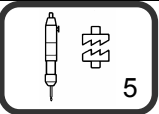
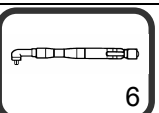
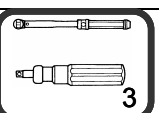
Mode	Mode (Frequency)	How it works.	Visual representation
	TRACK (500 Hz)	Follows signal.	
	Dial & Electronic (500 Hz)	Holds the highest reading until RESET by the user. [ The highest reading can be automatically reset if AUTO is selected for PEAK MEMORY RESET. After the value returns to zero, the memorised reading is held for the AUTO RESET HOLD TIME, then resets ].	
	Impulse Tool (500 Hz)		
	Clutch Tool (500 Hz)		
	Stall Tool (500 Hz)		
	Click & Cam (500 Hz)		

TIP. To simplify operation DISABLE all modes of measurement that are not required. See SETTINGS, MODES ENABLE/DISABLE menu.

TIP. The peak reading can be set up to automatically reset by changing PEAK MEMORY RESET from MANUAL to AUTO. See SETTINGS, THRESHOLDS

TIP. For slower operation of any AUTO RESET mode, change AUTO RESET HOLD TIME to 4 SECOND. See SETTINGS, THRESHOLDS menu.

TIP. In CLICK & CAM mode the serial port will only output for a genuine first peak. Pressing enter or ZERO will not send an output.

TIP. If torque wrench readings are inconsistent in CLICK & CAM mode, change FIRST PEAK SENSITIVITY in the SETTINGS, THRESHOLDS menu to be less sensitive i.e. MEDIUM or LOW. This will compensate for torque wrench sensitivity.



**POWER SAVING & POWER DOWN:-** \_\_\_\_\_

Battery life can be greatly increased from a minimum of 14 hours by making use of power down. If no key is pressed or measurement reading taken in the specified time, the TTT will enter power down. The following will be displayed:

SAVING POWER

PRESS ANY KEY TO CONTINUE

The following features should be noted:

- The POWER DOWN TIME is set in the SETTINGS, POWER DOWN TIME.
- For maximum battery life set POWER DOWN TIME to 1 minute.
- To disable the power down feature set POWER DOWN TIME to 0 (zero).
- The TTT also enters power down when in a set up menu.
- The analogue output will NOT work during power down.

**TIP.** Check the zero setting of the transducer on return from power down.

When the battery is low there is approximately 20 minutes of use left. In the measure screen a flashing battery symbol will be seen in the top right hand corner of the display. In a SET UP menu, the following is displayed:

WARNING #202

BATTERY LOW

PRESS X

When battery is flat the TTT must be turned off or recharged. The following is displayed:



WARNING #201

BATTERY FLAT  
SWITCH OFF AND RECHARGE BATTERY

*NOTE: - From a very flat battery it may take 1 minute of mains power before the display will turn on.*

**LIMITS:-** \_\_\_\_\_

Limits can be selected In Measure by pressing  or  .

The target is shown at the top left of the screen and if no limits have been set, the TIME & DATE will be shown. If limits are available but not selected, '??LIMITS OFF' will be shown.

The limit status is shown in 4 ways:

1. On the display showing LO / OK / HI next to the torque value (updated at 3 Hz).
2. On AMBER / GREEN / RED LED's on front panel (updated at 208 Hz).
3. On the Serial Port LO / OK / HI is sent before torque value (updated with serial port).
4. On the Ancillaries LO / OK / HI logic outputs (updated at 208 Hz).

**TIP.** The Ancillaries are updated quickly to give a fast response to an external control system.

*NOTE: This difference in update rate may lead to very small differences between the changeover points.*

The LED's & logic outputs change precisely with increasing torque, and at 0.5% of transducer capacity below the limit with decreasing torque. This eliminates the logic lines oscillating.

The status of the limits changes as follows:

Torque signal	Display	LED's	Serial port	Ancillaries
Zero band. (<0.5% of transducer capacity)	OFF	OFF	No output	No output
Under lower limit	LO	AMBER	LO	LO output
Within limits	OK	GREEN	OK	OK output
Above upper limit	HI	RED	HI	HI output

*NOTE: - For operation of limits in one direction only, the opposite direction will be shown as LO.*

The limit operation is dependent on the measurement mode:

<b>Measurement mode</b>	<b>Limit operation</b>
Track	Limits follow the transducer input and are not held.
Dial & Electronic Impulse tool Clutch tool Stall tool	For PEAK MEMORY RESET = MANUAL, Limits status is held until PRINT / RESET is pressed.  For PEAK MEMORY RESET = AUTO, Limit status is held until after the auto reset timer has operated.
Click & Cam	Limit status is held until after the auto reset timer has operated.

TIP. When TTT is switched on, the target shown is the last one used.

TIP. The TTT will automatically change torque units to those set by the limits.

TIP. Limits can be set up in USER units for operation with transducers programmed with the same USER units.

## TRANSDUCER INTERFACE

### INTRODUCTION:- \_\_\_\_\_

The 3 transducer connectors are designed for use with most four wire bridge strain gauge type transducers.

When used with Norbar 'SMART' transducers the calibration data will be automatically known.

For 'NON-SMART' transducers up to 20 sets of transducer parameters can be stored in the TTT for ease of use. These can be configured with USER units.

**TIP.** Mark 'NON-SMART' transducers with their stored 'T' number for ease of identification.

Ensure transducer selection switch is in the correct position for the transducer in use. See the TD#1, TD#2 & TD#3 symbols next to transducer connectors.

**TIP.** Press '#' in track mode to show details of transducer in use.

**TIP.** If any of the transducer's parameters are changed i.e. re-calibration of mV/V value, the transducer's stored parameters must be edited prior to use. ('NON-SMART' only).

Norbar transducers with the following suffix are all suitable for use with the TTT:

Suffix	Description
XXXXX.IND	'SMART' transducer calibrated in mV/V.
XXXXX.INDA	'SMART' transducer with integral angle encoder calibrated in mV/V.
XXXXX.LOG	'SMART' transducer calibrated with a TTT in units of calibration. A mV/V figure is also supplied.
XXXXX.LOGA	'SMART' transducer with integral angle encoder calibrated with a TTT in units of calibration. A mV/V figure is also supplied.

*NOTE: - Transducers supplied for use with the Pro-Log are compatible with the TTT. The TTT will not display angle when interfaced to a .INDA or .LOGA transducer.*

*ETS Transducers supplied with an amplifier module will need to be modified for use with the TTT.*

### TRANSDUCER LEADS AVAILABLE:- \_\_\_\_\_

Part Number	Description
60216.200	TTT to 10 way lead, for Norbar Rotary Transducers.
60217.200	TTT to 6 way lead, for Norbar Static & Annular Transducers.
60223.200	TTT to no connector (for non-Norbar transducers).

*NOTE: - The suffix after the part number indicates the length of the lead in cm, thus XXXXX.200 = 2 metres. If Transducer leads are required of a non-standard length, the new suffix must be added to the part number when ordering (to the nearest metre).*

**SPECIFICATIONS:-** \_\_\_\_\_

Parameter	Minimum	Maximum
Bridge Resistance ( $\Omega$ ).	350 $\Omega$	1000 $\Omega$
Millivolt / volt value (mV/V).	0.95 mV/V.	3.15 mV/V.
Zero balance.	+/- 3% of transducer capacity (3 mV/V).	+/- 9% of transducer capacity (1 mV/V).
Display Resolution.	4.5 Active digits.	5 Active digits.
Transducer capacity ranges.	0.010000	1,500,000
Torque units	Dependent on transducer capacity and mV/V value.	N.m, dN.m, cN.m, lbf.ft, lbf.in, ozf.in, ft.lb, in.lb, in.oz, kgf.m, kgf.cm, gf.m, gf.cm.
User units.	None.	6 Characters.
Displayable overrange.	120% of transducer capacity.	

**PIN CONNECTIONS:-** \_\_\_\_\_

Pin No	Function
1	+ve transducer excitation.
2	-ve transducer excitation.
3	+ve transducer signal.
4	-ve transducer signal.
5	Digital 0 volts.
6	Digital +5 volts for transducer selected, digital 0 volts when not selected.
7	Rotary transducer angle input (Channel A).
8	Rotary transducer angle input (Channel B).
9	Serial clock (SMART memory).
10	Serial data (SMART memory).

**CONNECTOR TYPE:-** \_\_\_\_\_

Lemo® 10 way panel socket, size 2B. The mating part to this connector is a Lemo 10 way, size 2B free plug, manufacturers part number FGG.2B.310.CLAD722.

TIP. If the display shows 'SMART TD NOT INITIALISED' it is likely that:

- Unmodified ETS transducer connected.
- The transducer lead may have a broken connection.
- 'SMART' transducer may have lost its stored data, return to Norbar.

## ANCILLARIES

### INTRODUCTION:-

The ancillaries connector contains GO / NO GO control limits for external equipment, an analogue signal output and a PRINT / RESET signal input.

### PIN CONNECTIONS:-

Pin No	Function
1	Digital +5 volts (maximum current 5 mA).
2	External PRINT / RESET input (Active High).
3	Low limit output (LO).
4	Pass limit output (OK).
5	High limit output (HI).
6	Not Used.
7	Not Used.
8	Auto reset display hold input (Active high).
9	Digital 0 volts.
10	First Peak Detect output (High when first peak active).
11	Analogue Output.
12	Analogue Output 2.5V.
13	Analogue Output 0V reference (Do not connect to a noisy electrical ground).
14	Rotary transducer angle output (Channel A).
15	Rotary transducer angle output (Channel B).

TIP. The angle output is available for a Norbar Rotary Transducer. For use see Rotary Transducer handbook.

### EXTERNAL PRINT / RESET:-

Pins 1 & 2 are intended for use as an EXTERNAL PRINT / RESET:-

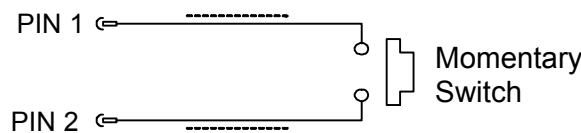

The switch must remain active for at least 200 mS. Screened cable is recommended.

### LIMIT OUTPUTS:-

Pins 3, 4 & 5 are buffered logic outputs intended for Go/No Go control of external equipment. All limit outputs are referenced to Pin 9 (Digital 0V). All limit outputs are active HIGH & change at 208 times per second. For more information on limits, see 'LIMITS' menu which can be accessed via the 'SET UP' menu.

Limit output current, High = -0.8 mA, Low = 16 mA (not for direct control of relays).

**ANALOGUE OUTPUT:-** \_\_\_\_\_

The analogue output is designed for connection to a control system. It is a true analogue value, so has a very fast frequency response of above 10 kHz. The calibration of the analogue output is factory set and not adjustable, it is not affected by the instrument calibration.

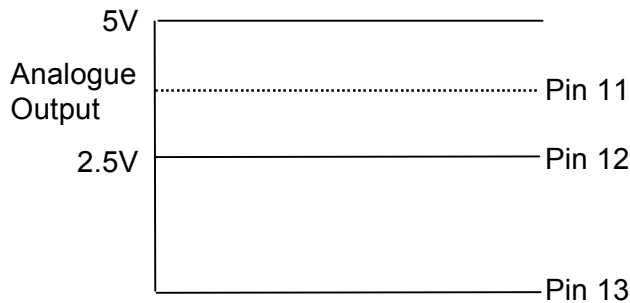

The analogue output is PIN 11.

If the output is measured against PIN 12 (2.5V) the signal will swing positive for clockwise torque and negative for anticlockwise torque.

If the output is measured against PIN 13 (0V) the signal will always be positive, with zero torque around 2.5V.

**TIP.** Some transducers (Norbar Annular type) will give a negative output change for a positive torque. This is because they are designed to measure reaction torque.

The output voltage is a function of the mV/V value. The larger the mV/V value the larger the analogue output voltage. At transducer full scale the analogue output voltage (in volts) is numerically equal to the mV/V value divided by 2.

**TIP.** Find the mV/V value by pressing '#' in the track mode or refer to the transducer's calibration certificate.

Using 2.5V (PIN12) as a reference:

Torque	Analogue output (PIN 11)		
	@ 1.0mV/V	@ 2.0 mV/V	@ 3.0 mV/V
- full scale of transducer	-0.5 V	-1.0 V	-1.5 V
Zero	0.0 V	0.0 V	0.0 V
+ full scale of transducer	+0.5 V	+1.0 V	+1.5 V

Using 0V (PIN13) as a reference:

Torque	Analogue output (PIN 11)		
	@ 1.0mV/V	@ 2.0 mV/V	@ 3.0 mV/V
- Full scale of transducer	2.0 V	1.5 V	1.0 V
Zero	2.5 V	2.5 V	2.5 V
+ Full scale of transducer	3.0 V	3.5 V	4.0 V

**TIP.** The analogue output will not operate in power down mode. If using the analogue output continuously then disable the power down feature by setting to 0 (zero).

The accuracy of the analogue output is +/- 2% of voltage reading. For a more accurate output value the voltage can be externally scaled against the displayed torque.

**CONNECTOR TYPE:-** \_\_\_\_\_

15 way female 'D' type connector.

## SERIAL PORT

### INTRODUCTION:-

The serial port is for sending data to a PC or serial printer.

When the TTT is measuring, data can be output on the serial interface automatically when the AUTO RESET timer operates or when the 'PRINT / RESET' key is pressed. The data can include the measured value, units of measurement and time/date. Output can also be requested externally via pin 2 (ancillaries connector), see ancillaries section.

### SPECIFICATIONS:-

Parameter	Options	Factory Defaults	Comments
Parity	ODD, EVEN or OFF.	OFF	
Baud rate	1200, 2400, 4800, 9600 or 19200.	9600	The data rate.
Data - Stop bits	8 - 2, 8 - 1, 7 - 2, 7 - 1.	8 - 2	
First character	- or +/- or NONE.	-	If required by receiver.
Output Limits	YES or NO.	YES	Limit status sent before data.
Output units	YES or NO.	YES	Measurement units sent after data.
Output date & time	YES or NO	NO	Date & Time sent after data.
Output line feed	YES or NO	NO	Line feed sent after data.
Handshake	NONE, CTS or X-ON/OFF	NONE	If required by receiver.
Line delay	0.00 to 9999 SECONDS	0.50 Seconds	Time delay in data output.
Continuous output	YES or NO	NO	Up to 22 readings per second in track mode.
	SET TO FACTORY DEFAULTS		

Maximum number of characters per line = 24.

Maximum number of requests in track mode = 4 per second (line delay set to 0).

Transmitted data voltage levels are between +5 to +9 volts and -5 to -9 volts.

Configured as DTE (Data Terminal Equipment) and conforms to RS-232-C specifications.

**TIP.** If the serial port is not communicating with other equipment try:

- a) Check that all serial port parameters on the TTT and the equipment receiving data match.
- b) Check that the baud rate is set to the same as the equipment receiving data.
- c) Check that the connecting lead is wired correctly at both ends.
- d) Check if equipment receiving data requires the units of measurement inhibited or a leading character.
- e) Select CONFIRM at the end of the serial port settings, the TTT will keep sending a 'TEST OUTPUT' message to help fault finding.



**TIP.** If the serial output is being overwritten set 'Output Line Feed' to YES.

**TIP.** If the Serial data is being sent too quickly the printer may not keep up, so data is lost. To slow down the TTT output change the 'Line delay' function.

### **PULSE COUNT:-** \_\_\_\_\_

When in IMPULSE TOOL or CLUTCH TOOL modes, the pulse count is output on the next line following the measured value. The pulse count will be output as follows '\_\\_##=XXXX'. XXXX represents the number of pulses.

### **HYPERTERMINAL:-** \_\_\_\_\_

The standard HyperTerminal® program found in Microsoft® Windows allows the user to view and store serial output data. For more information see [www.norbar.com](http://www.norbar.com) and select FAQ.

**TIP.** Downloading of data can be speeded up by changing the LINE DELAY to 0 SECONDS.

**TIP.** To regulate the CONTINUOUS OUTPUT, set LINE DELAY to required time period.

### **LIMITS:-** \_\_\_\_\_

The serial port will output LO / OK / HI when the limits are being used. Some software, including the Norbar 'Torque Wrench Calibration Software' (Part 37705.XXX), will not accept LO / OK / HI characters. To remove LO / OK / HI set OUTPUT LIMITS to 'NO'.

The following table gives all options for the FIRST CHARACTER & OUTPUT LIMITS settings:

<b>FIRST CHARACTER</b>	<b>Direction:</b>	<b>Example with No Limits or OUTPUT LIMITS = NO</b>	<b>Example with OUTPUT LIMITS = YES</b>
-	Clockwise	1.0335 N.m	LO 1.0335 N.m
	Anti Clockwise	-1.0335 N.m	LO -1.0335 N.m
+/-	Clockwise	+1.0335 N.m	LO +1.0335 N.m
	Anti Clockwise	-1.0335 N.m	LO -1.0335 N.m
NONE	Clockwise	1.0335 N.m	LO 1.0335 N.m
	Anti Clockwise	1.0335 N.m	LO 1.0335 N.m

**PIN CONNECTIONS:-** \_\_\_\_\_

Pin No	Function
1	Not Connected.
2	Received data (to TTT).
3	Transmitted data (from TTT).
4	Not Connected.
5	Signal ground 0V.
6	Not Connected.
7	Not Connected.
8	CTS (clear to send).
9	Not Connected.

**DATA OUTPUT EXAMPLE:-** \_\_\_\_\_

Code: DP=Decimal Point. CR=Carriage Return. SP=Space.  
TTT with the serial port set to the factory defaults. Reading 1068.4 lbf.ft (clockwise).

1	0	6	8	DP	4	SP	l	b	f	DP	f	t	CR
---	---	---	---	----	---	----	---	---	---	----	---	---	----

**CONNECTOR TYPE:-** \_\_\_\_\_

9 way male 'D' type connector.

**CONNECTING LEAD:-** \_\_\_\_\_

A 9 way female to 9 way female null modem connecting lead is included with the TTT for connection to a PC with a 9 way male connector.

TIP. If PC to be used has a 25 way 'D' connector, use the Serial Data Lead Kit (part no 60248).

## SPECIFICATIONS

Input voltage	Equivalent torque	Accuracy	Calibration uncertainty*
@0.5 mV	5% of full scale	±0.1% of reading	±0.13%
@1.0 mV	10% of full scale	±0.05% of reading	±0.08%
@2.0 to 18.9 mV	20% to 120% full scale	±0.05% of reading	±0.06%

\*Using a coverage factor of k=2, to give a confidence level of approximately 95%.

Resolution	5 active digits for all Norbar transducers.
Display	240 x 64 pixel dot matrix display. With update rate of three times per second (3Hz).
Torque unit conversions	To 'BS 350:2004 Conversion factors for units'.
Zero suppression	TRACK None. ALL OTHER MODES suppressed from 0 to 0.5% of transducer calibration range.
Password	000000 (default), must be 6 characters.
Time/date	HH:MM:SS 24 Hour clock. DD/MM/YY or MM/DD/YY date format.
Time/date compliance	To year 2062.
Units of measurement	See TRANSDUCER INTERFACE section. USER defined up to a maximum of 6 alpha numeric upper and lower case characters.
First peak sensitivity	2.5%(High), 5%(Medium), or 10%(Low) of reading.
Auto reset hold time	1, 2, 3 or 4 seconds.
Peak mode reset	Auto or Manual.
Trigger from setting	0 to 99% of transducer capacity.
Frequency response	8 <sup>th</sup> Order Butterworth low pass filter with a -3dB point settable from 100 to 2500 Hz.
Operating temperature range	+5°C to +40°C.
Storage temperature range	-20°C to +70°C.
Maximum operating humidity	85% Relative Humidity @30°C.
a.c. power adapter	90 to 264 Volts a.c. at 50-60 Hz input. 9V, 300 mA d.c. output (centre positive).
Power down time	1 to 99 minutes (enter 0 to disable).
Power consumption	2.4 W - maximum.
Power cable	2 metres (6 ft 6 ins) long minimum.
Power plug fuse (if fitted)	1 Amp.
Battery pack	1500 mAh, 6.0 volt (5 cell) NiMH (Recharge time 200 minutes).
Coin cell	Renata 190 mAh (CR2032FH).
Weight	1 Kg (2.2 lb).
Dimensions	162 mm high x 200 mm wide x 180 mm deep.
Case materials / finish	Rigid polyurethane with fine texture acrylic paint finish.
Environment	Indoor use within a light industrial environment.
Electromagnetic Compatibility (EMC) Directive	In conformance with EN 61326 : 1997.
Low voltage directive	In conformance with EN 61010-1 : 2001. To environmental conditions Pollution Degree 2 & Installation Category (Over voltage Category) II.

*Due to continuous improvement all specifications are subject to change without prior notice.*

## MAINTENANCE

### TTT CALIBRATION:- \_\_\_\_\_

Your TTT has been supplied with a certificate of calibration. To maintain the specified accuracy it is recommended that the TTT is recalibrated at least once per year. Re-calibration should be carried out at Norbar or by a Norbar approved agent, where all the facilities to ensure the instrument is functioning at maximum accuracy are available.  
Do not remove front panel or case; there are no calibration settings inside.

### TRANSDUCER CALIBRATION:- \_\_\_\_\_

To maintain the specified accuracy it is recommended that transducers are recalibrated at least once per year. Re-calibration and repair should be carried out at Norbar or by a Norbar approved agent.

### BATTERY REPLACEMENT:- \_\_\_\_\_

There are 2 batteries in the TTT.

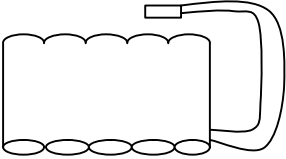
Description	Use	Reason for replacement	Battery markings	Norbar part #
Coin cell 3V 	Time & date	Time & date fail	CR2032	39202
Battery pack 6V NiMH 	Powers TTT	TTT has short battery life	38876	38876

To replace battery(s):

1. Turn TTT off.
2. Remove 4 front screws with 2.5mm HEX key.
3. Lift the top of the panel to show PCB.
4. Replace coin cell (marked BATT1 on PCB) and / or replace battery pack (marked CONN4 on PCB).
5. Fit panel without trapping any internal wires and refit 4 front screws.

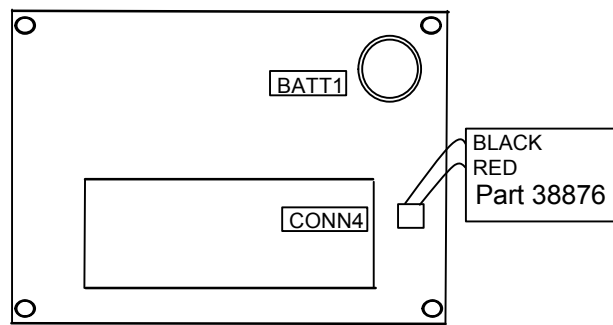

Inside TTT.

Dispose of used battery in a safe way. Do not incinerate, mutilate or short circuit.

### REPAIR:- \_\_\_\_\_

Repair should be carried out at Norbar or by a Norbar approved agent, where all the facilities to ensure the instrument is functioning at maximum accuracy are available.

Only remove front panel for battery replacement; there are no other parts for user repair inside.

### CLEANING:- \_\_\_\_\_

Do not use abrasives or solvent based cleaners.

## TROUBLE SHOOTING

Tips are located within the handbook to help with troubleshooting.

### ERROR MESSAGES:- \_\_\_\_\_

Error messages are displayed to help the user, with audible warnings given when necessary. Common error messages are:

Error #	Message	Comment
312	TRANSDUCER CAPACITY > 1,500,000	Wrong value entered.
313	TRANSDUCER CAPACITY < 0.01	Wrong value entered.
314	CALIBRATION FIGURE NOT 0.95 TO 3.15 MV/V	Wrong value entered.
316	NO TRANSDUCER TO EDIT / PRINT	No stored transducers.
317	DELETE A SAVED TRANSDUCER FIRST	All 20 locations full.
318	SET + LIMIT TOO HIGH	Wrong value entered.
319	SET - LIMIT TOO HIGH	Wrong value entered.
320	INCORRECT TARGET VALUE	Wrong value entered.
321	FREQUENCY NOT 100 Hz – 2500 Hz	Wrong value entered.
322	POWER DOWN TIME 0-99 MINUTES	Wrong value entered.
324	SMART TRANSDUCER NOT INITIALISED	Transducer's stored data is blank.

### PROBLEMS:- \_\_\_\_\_

Problem	Likely Solutions
No TTT display.	Check on/off switch is ON. Charge battery for at least 1 minute.
Battery will not charge.	Check display backlight is ON when charging. Check a.c. power adaptor is ON (green LED on power adaptor will glow). Check electrical power supply and fuse in plug (if fitted).
Displays Menu 82: 'CLOCK NOT INITIALISED'	The coin cell battery has failed. See MAINTENANCE section or return to Norbar.

For more complex faults please contact Norbar distributor / manufacturer.

**GLOSSARY OF TERMS**

<b>Word or Term</b>	<b>Meaning</b>
a.c.	Alternating current.
Auto Reset Hold Time	The length of time a reading is displayed until automatically reset.
d.c.	Direct current.
ETS	Electronic Transducer System.
First Peak Sensitivity	The amount by which the reading must fall from a peak for the display to be held.
Frequency Response	Frequency value below which signals are passed.
Hz	Hertz, unit of frequency.
LED	Light Emitting Diode.
Lemo	Reference for manufacturers of connector.
mA (milli amp)	One thousandth of an amp.
mAh (milli ampere hour)	Rate of charge/discharge of a battery.
mS (Millisecond)	One thousandth of a second (0.001 second).
mV (Millivolt)	One thousandth of a volt (0.001 volt).
mV/V (Millivolt per volt)	Ratio of millivolt output to voltage input.
NiMH	Nickel metal Hydride.
NON-SMART	Standard mV/V transducer (NON-INTELLIGENT).
PC	Personal Computer.
PCB	Printed Circuit Board.
Power Down Time	The length of time that the TTT has not been used before the instrument goes into power down mode.
√ Print / X Print	Print can be switched off to stop all serial port output.
Pulse Count	The number of torque pulses that have been applied to the TTT in IMPULSE TOOL or CLUTCH TOOL mode.
SMART	Serial Memory Automatic Recognition Transducer (INTELLIGENT).
SMART Transducer	A transducer that holds its own calibration data (INTELLIGENT).
Trigger From	Value at which the memory modes operate. Used to overcome erratic applications of torque causing false results.
TTT	Torque Tool Tester.
USER	Measurement units that can be specified by the user.
V d.c.	Voltage (direct current).
Zero Suppression	Value of torque that has to be achieved for the TTT not to display zero.